

SPEC SHEET 240T - 240ML TUB

PRODUCT DIMENSIONS

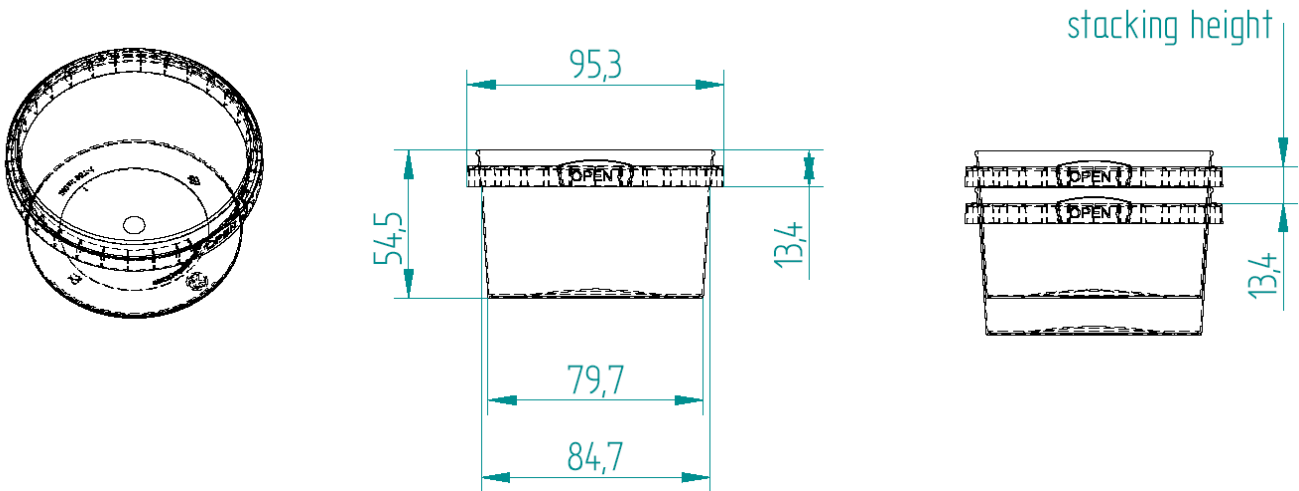

TAMPER EVIDENCE	Tamper evidence break-out tab
WEIGHT	10.8 g
CAPACITY	240 ml
SHAPE	Round Conical
LID OPTIONS	L95 Snap On
DECORATION	In-Mould-Labeling (IML) options are available in various film substrates
MATERIAL	Polypropylene This product meets the purity limits as stated in AS2070-1999, which relates to plastic materials suitable for food contact applications.
COLOURS	Natural, Clear, White, Black, Customer specific colours on request
APPLICATION	<ul style="list-style-type: none"> • Room Temperature / Fridge: standard material • Freezer: special material required • Hot Filling: special material required <p>In all cases, customer should conduct its own trials to ensure the suitability of this packaging for its chosen application</p>
FEATURES	Re-heating (may be microwaved), leak resistant, tamper evident
PACKAGING	<p>QTY per carton: 630</p> <p>Carton size: 620 x 510 x 340 mm</p> <p>Carton liner: HDPE blue plastic liner bag</p> <p>Full carton weight: 8 kg</p> <p>Pallet size: 1165 x 1165 x 2180 mm (max 24 boxes per pallet)</p>

